



Rail Kit Installation Manual

1. Rail kit installation

1.1 Tool-less Friction Rail Kit

The tool less design of the rail kit allows you to easily install the rack rails into the server rack without the need for additional tools. The kit also comes with a metal stopping bracket that can be installed to provide additional support and stability to the server.

The tool-less rail kit package includes:

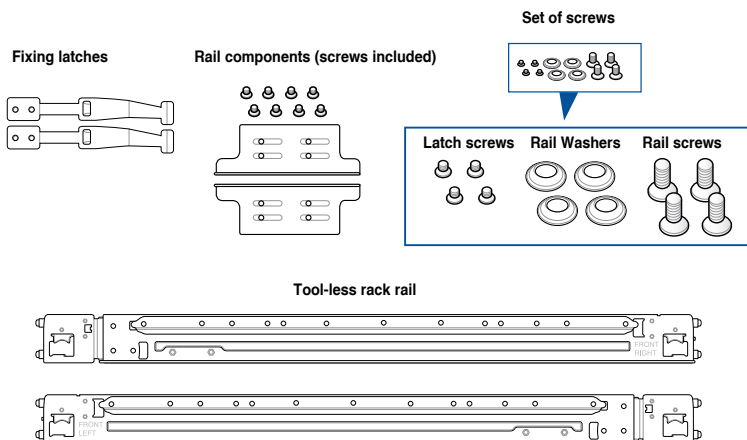

1.2 Installing the tool-less rack rail

To install the tool-less rack rails into the rack:

1. Secure the two fixing latches to the two sides of the server using the set of latch screws.



The locations of the screw holes vary with different server models. Refer to your server user manual for details.

For 1U devices

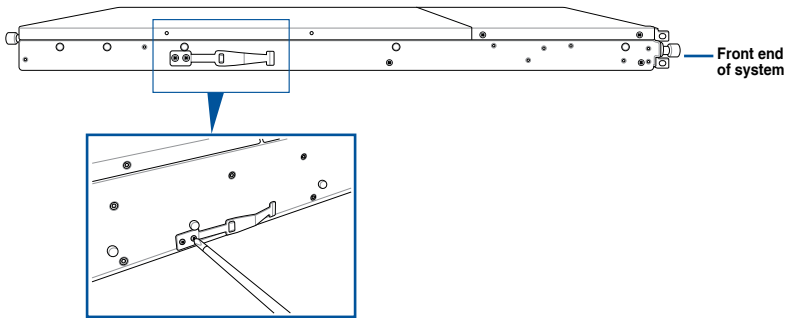

For 2U devices

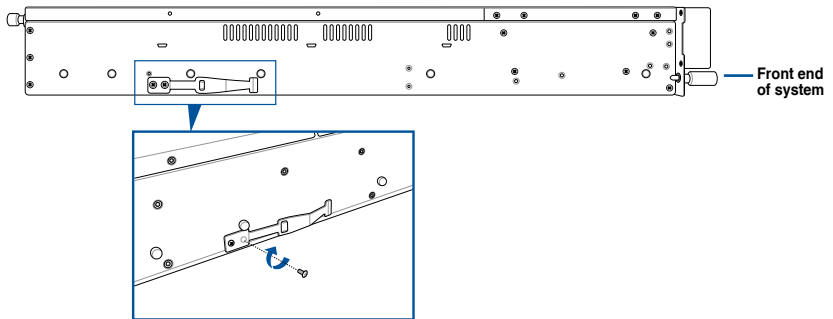



Follow steps 2 to 4 if the depth of your server rack exceeds 850mm, if the depth of your server rack is less than 850mm, please skip steps 2 to 4 and proceed with step 5.

2. Slightly slide out and extend the right rack rail, then prepare one of the bundled rail components.

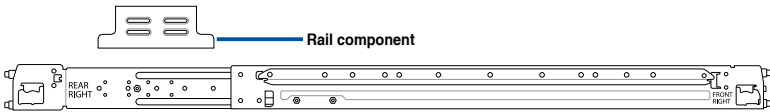

3. Align the rail component with the right rack rail and secure it using four (4) bundled screws.

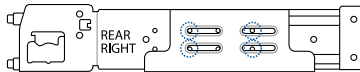

4. Follow steps 2 and 3 to secure the rail component to the left rail rack.
5. Select a desired space and place the appropriate rack rail (left and right) on opposite positions on the rack.



A 1U space is consists of three square mounting holes with two thin lips on the top and the bottom.

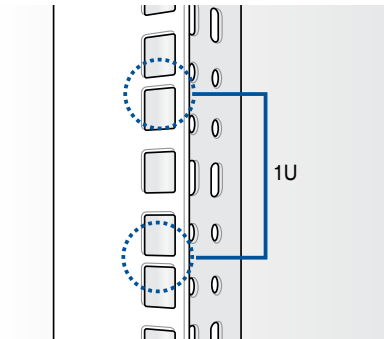

6. Secure the rail components to the rail using the bundled screws.
7. Press the spring lock (A) then insert the studs into the selected square mounting holes on the rack post.
8. Press the spring lock on the other end of rail then insert the stud into the mounting hole on the rack post. Extend the rack rail, if necessary.
9. (Optional) Use the rail screw and rail washer (B) that comes with the kit to secure the rack rail to the rack post.
10. Perform steps 3 to 5 for the other rack rail.



Ensure that the installed rack rails (left and right) are aligned, secured, and stable in place.

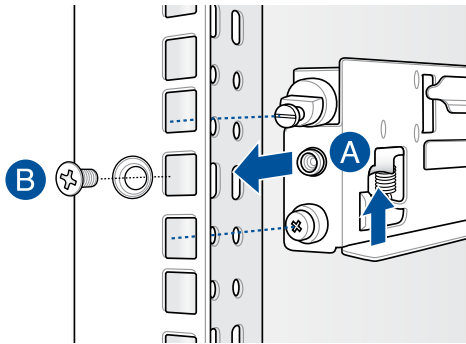

8. Lift the server chassis and insert into the rack rail.



Ensure that the rack rail cabinet and the rack posts are stable and standing firmly on a level surface.

2. Rail kit dimensions

